

N-Channel Enhancement Mode Field Effect Transistor

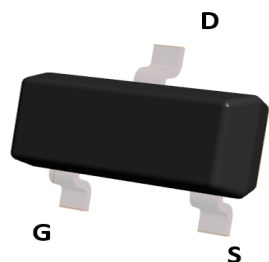

Top View

SOT-323

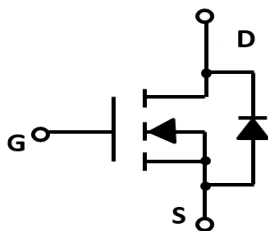
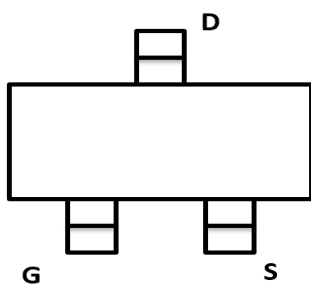

Product Summary

- V_{DS} 20V
- I_D 2.0A
- $R_{DS(ON)}$ (at $V_{GS}=4.5V$) < 68 mohm
- $R_{DS(ON)}$ (at $V_{GS}=2.5V$) < 115 mohm

General Description

- Trench Power LV MOSFET technology
- High Power and current handling capability

Applications

- PWM application
- Load switch

■ Absolute Maximum Ratings ($T_A=25^\circ C$ unless otherwise noted)

Parameter	Symbol	Limit	Unit
Drain-source Voltage	V_{DS}	20	V
Gate-source Voltage	V_{GS}	± 10	V
Drain Current	I_D	2.0	A
Pulsed Drain Current ^A	I_{DM}	14	A
Total Power Dissipation @ $T_A=25^\circ C$	P_D	0.7	W
Thermal Resistance Junction-to-Ambient @ Steady State ^B	$R_{\theta JA}$	178	$^\circ C/W$
Junction and Storage Temperature Range	T_J, T_{STG}	-55~+150	$^\circ C$

■ Electrical Characteristics ($T_J=25^{\circ}\text{C}$ unless otherwise noted)

Parameter	Symbol	Conditions	Min	Typ	Max	Units
Static Parameter						
Drain-Source Breakdown Voltage	BV_{DSS}	$V_{GS}=0V, I_D=250\mu A$	20			V
Zero Gate Voltage Drain Current	I_{DSS}	$V_{DS}=20V, V_{GS}=0V, T_C=25^{\circ}\text{C}$			1	μA
Gate-Body Leakage Current	I_{GSS}	$V_{GS}=\pm 10V, V_{DS}=0V$			± 100	nA
Gate Threshold Voltage	$V_{GS(th)}$	$V_{DS}=V_{GS}, I_D=250\mu A$	0.45	0.75	1.2	V
Static Drain-Source On-Resistance	$R_{DS(on)}$	$V_{GS}=4.5V, I_D=2.0A$		50	68	m Ω
		$V_{GS}=2.5V, I_D=1.5A$		65	115	
Diode Forward Voltage	V_{SD}	$I_S=2.0A, V_{GS}=0V$			1.2	V
Maximum Body-Diode Continuous Current	I_S				2.0	A
Dynamic Parameters						
Input Capacitance	C_{iss}	$V_{DS}=10V, V_{GS}=0V, f=1\text{MHZ}$		280		pF
Output Capacitance	C_{oss}			46		
Reverse Transfer Capacitance	C_{rss}			29		
Switching Parameters						
Total Gate Charge	Q_g	$V_{GS}=4.5V, V_{DS}=10V, I_D=4.3A$		2.9		nC
Gate Source Charge	Q_{gs}			0.4		
Gate Drain Charge	Q_{gd}			0.6		
Turn-on Delay Time	$t_{D(on)}$	$V_{GS}=4.5V, V_{DD}=10V, R_L=1.5\Omega, R_{GEN}=3\Omega$		13		ns
Turn-on Rise Time	t_r			54		
Turn-off Delay Time	$t_{D(off)}$			18		
Turn-off Fall Time	t_f			11		

A. Pulse Test: Pulse Width $\leq 300\mu s$, Duty cycle $\leq 2\%$.

B. Device mounted on FR-4 PCB, 1 inch x 0.85 inch x 0.062 inch.

■ Typical Performance Characteristics

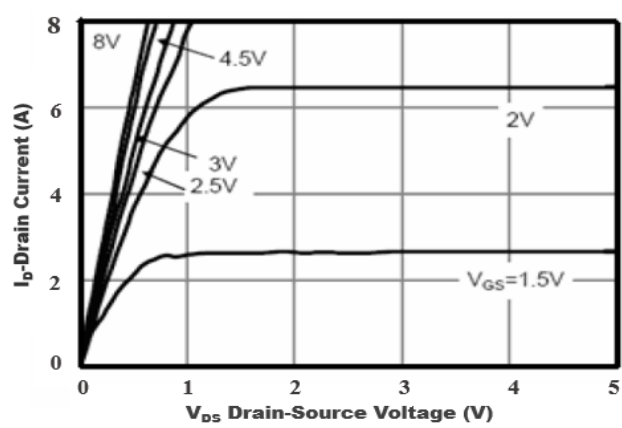

Figure1. Output Characteristics

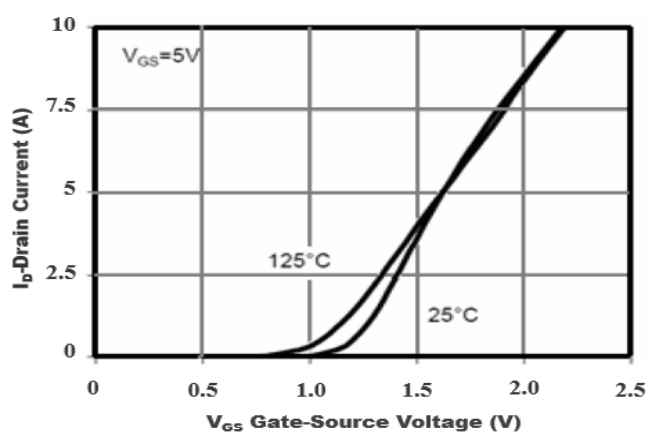

Figure2. Transfer Characteristics

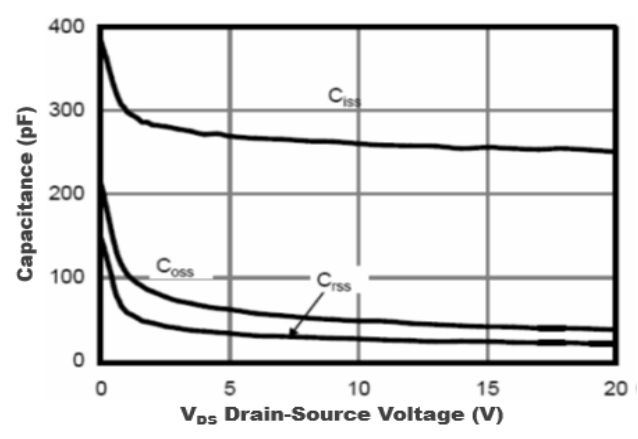

Figure3. Capacitance Characteristics

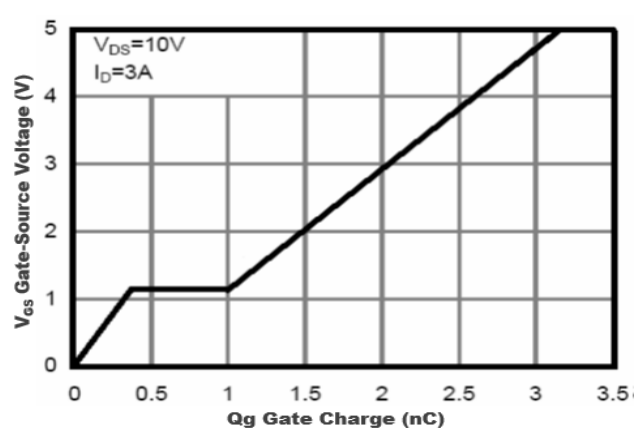

Figure4. Gate Charge

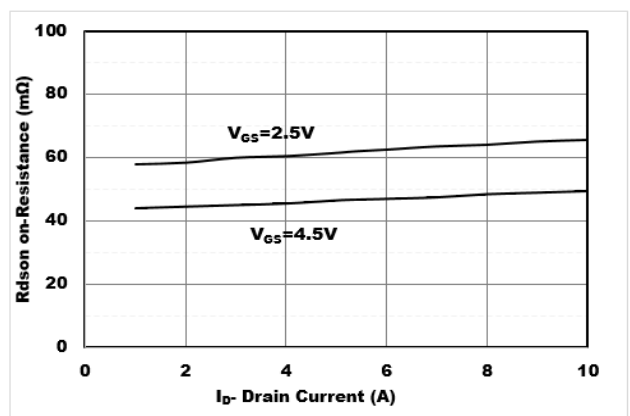

Figure5. Drain-Source on Resistance

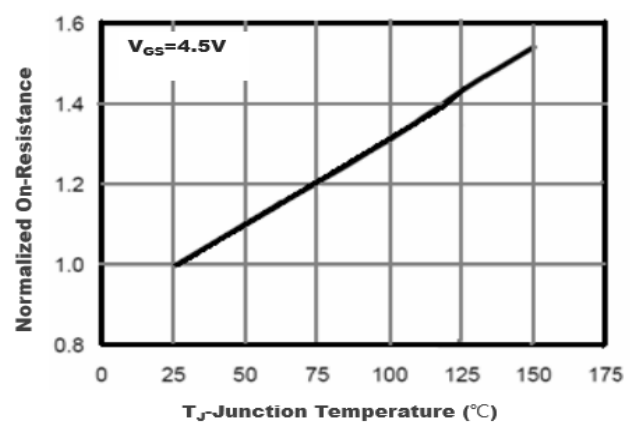
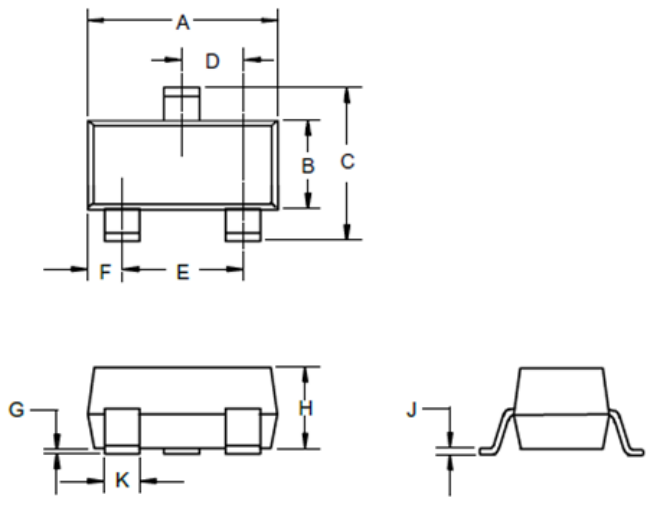

Figure6. Drain-Source on Resistance

■ SOT-323 Package information



DIMENSIONS					
DIM	INCHES		MM		NOTE
	MIN	MAX	MIN	MAX	
A	.071	.087	1.80	2.20	
B	.045	.053	1.15	1.35	
C	.083	.096	2.10	2.45	
D	.026 Nominal		0.65Nominal		
E	.047	.055	1.20	1.40	
F	.012	.016	.30	.40	
G	.000	.004	.000	.100	
H	.035	.039	.90	1.00	
J	.004	.010	.100	.250	
K	.006	.016	.15	.40	

■ SOT-323 Suggested Pad Layout

